

Heavy - Heavy Duty

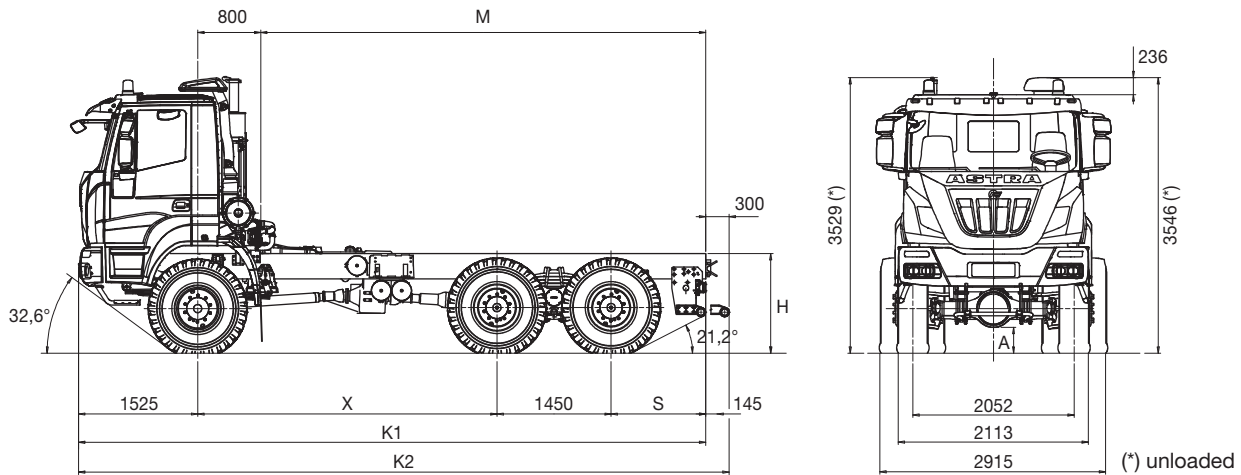

G.V.W. 50.000 kg

**chassis 6x6
66.48 / 66.54**



TYRES
14.00R20

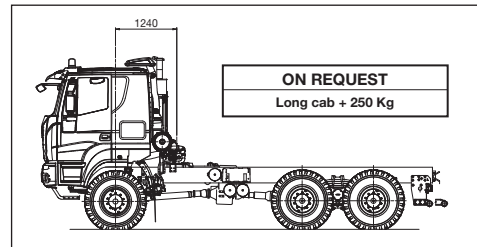

DIMENSIONS (mm) short cab

wheelbases	X	K1	K2	M	S	S ON REQUEST	H		TURNING DIAMETER
							UNLOADED	LOADED	
C	3800	7975	8275	5210	1200		1307	1243	21470
D	4100	8275	8575	5510	1200	1500-1900			22730
E	4500	8675	8975	5910	1200	1500-1900			24420

WEIGHT (kg)

wheelbases	Distribution net weight (*)			Max technical weight			
	1 st axle	2 nd + 3 rd axle	NET WEIGHT	1 st axle	2 nd + 3 rd axle	Gross Vehicle weight	Gross Combination Weight
C	6135	5745	11880	10000	40000	50000 (**)	250000
D	6265	5640	11905				
E	6445	5535	11980				

(*) Weight including oil, fuel, spare wheel, driver Kg.75
 (**) At max speed 70 Km/h.

Technical limits depending on configuration and mission

Technical data and general specifications - validity to be checked according to each individual country





ENGINES

CURSOR 13 turbo intercooler euro 3 diesel injection/cycle with electronic unit injection pumps. 6 in-line cylinders. Single block head, four valves per cylinder, light alloy pistons. Total displacement: 12.882 cm³. Bore for stroke: 135 x 150 mm. Water cooling. Viscostatic cooling fan. Dry air filter with safety cartridge. Vertical muffler.

	66.48	66.54
Model	FPT Cursor F3B	FPT Cursor F3B
Max. power (EEC)	353 kW (480 HP)	397 kW (540 HP)
Corresponding rpm	1.900	1.900
Max. torque (EEC)	2.200 Nm (224 kgm)	2.350 Nm (240 kgm)
Corresponding rpm	1.000-1.440	1.000-1.690
Turbine	VGT variable geometry	



GEARBOX

Manual gearbox **ZF 16 S 2520 TO** with servoshift, 16 synchronised forward speeds + 2 reverse.

		Speed [kph] at maximum power rpm - Tyres 14.00R20																	
		Gears																	
		1	2	3	4	5	6	7	8	9	10	11	12	13	14	15	16	RM1	RM2
ZF 16 S 2520TO	Gear ratios	13,80	11,54	9,49	7,93	6,53	5,46	4,57	3,82	3,02	2,53	2,08	1,74	1,43	1,20	1,00	0,84	12,92	10,80
	Rear axle ratio with transfer 1:1.0 1:1,290	4,7	5,7	6,9	8,3	10,0	12,0	14,3	17,2	21,7	25,9	31,5	37,7	45,8	54,6	65,5	78,0	5,1	6,1

On request: Automatic gearbox Allison 4700 with or w/out **retarder** with closed loop adaptive shift, 7 forward speeds + 1 reverse. Torque converter TC-561. Stall torque ratio 1.58. Cab-mounted shift selector lever.

		Allison 4700							
		Gears							
		1	2	3	4	5	6	7	RM
Gear ratios		7,63:1	3,51:1	1,91:1	1,43:1	1,00:1	0,74:1	0,64:1	-480:1



P.T.O.

On request:

Gearbox	ZF16S2520TO	Mx. Torque	Application
P.T.O.	Ratio	Nm	
ZF NH/1b	0,91/1,09:1	1000	For tipping unit pumps, pumps for cranes, ecc...
ZF NH/1c	0,91/1,09:1	1000	For tipping unit pumps, unit pumps for concrete, pumps for cranes, ecc...
ZF NH/4c	1,17/1,40:1	430	For tipping unit pumps, ecc...



P.T.O. CHELSEA only for automatic gearbox Allison 4700

Gearbox	Allison 4700	Mx. Torque	Application
P.T.O.	Ratio	Nm	
859 XGF JP-5	1,08:1	780	For higher performance, 30t windlass...
277 XGF JP-D5XY	1,47:1	407	For standard application, tipping unit pumps, cranes, ecc...



CLUTCH

Single dry plate, diameter 17". Pull type engagement with diaphragm spring control. Hydro-pneumatic power steering engagement with driven disc wear recovery slave cylinder.

On request: 17" ceramic clutch.



TRANSFER ZF STEYR VG 2700

Mechanical with two ratios. It consists of a series of helical spur gears, mounted on three shafts, engaged with each other.

Differential lockable by pneumatic control.

Transmission ratio: 0:913 - 1,407

Front torque distribution ratio: 1,0

Rear torque distribution ratio: 2,6



SUSPENSIONS

FRONT

Parabolic springs with bushings, **5 leaves 24x90 mm**.

Hydraulic shock absorbers and standard stabilizer bar.

REAR

Parabolic springs, swivelling on central pin: **5 leaves 40x100 mm**. Supplemented by torque bars and stiffening brackets.

Stabilizer bar on the 3rd axle.



AXLES

FRONT

Driving and steering type for max technical weight 10.000 kg, with double reduction, central with pinion-crown wheel, side by means of epicycloidal assembly in wheel hubs.

On request:

Differential lockable by pneumatic control from driver's seat.

REAR

Two driving axles in tandem for max technical weight 40.000 kg. Double reduction: central with bevelled pair, final in the wheel hubs by means of epicycloidal assembly.

2nd axle with distributor for torque distribution between the two axles.

Differential lockable by pneumatic control from driver's seat.

Tandem assembled to the chassis by reaction rods with silentblock. Rear-axle ratio 1:7,29



CHASSIS

In steel with high elasticity limit consisting of two flat parallel side members (width 820 mm.) with C section (320x90x10 mm), jointed by nailed cross members. R.B.M. (Rail Bending Moment: 202.020 Nm (20.593 Kgm). Front bumpers in steel with headlamp protection grids, front manoeuvring hook, rear underrun bar, steel fuel tank, capacity 300 litres.

On request:

Rapid attachment for compressed air for tyres'inflation.

Rear underrun bar in set back position.

Rear manoeuvring hook.

Rear automatic towing hook.

Rubber mudguards on 2nd and 3rd axle.

Front bumper climbing step.



STEERING

Hydraulic power steering ZF 8099 with variable ratio 1:22.2/1:26.2, with auxiliary cylinder. Hydraulic pump flanged to engine. Steering linkage with self lubricating floating joints. Emergency steering pump:

- On gearbox with mechanical gearbox;

- On transfer-box with automatic gearbox.

Mechanically adjustable steering wheel for height and angle.



TYRES

FRONT: 14.00R20 Pirelli PS 22 Single tubeless

REAR: 14.00R20 Pirelli PS 22 Twin tubeless

Spare wheel on the chassis.



PNEUMATIC SYSTEM

Two-cylinder 630 cc compressor, APU (Air Processing Unit) that includes: regulation valve set at 10.3 bar, drier, 4-way safety valve, pressure reduction valve for parking circuit and services. 3 air tanks, capacity 30 litres + 2 with 20 litres.

ABS system and EBL (Electronic Brake Limiter).



BRAKES

Front "simplex", rear "duo-duplex" self-adjusting wedge type brakes with automatic play take-up. ABS.

Service brake: Pedal controlled air brake, acting on all wheels.

Solo vehicles, two independent circuits, one for 1st axle, one for 2nd and 3rd axle.

Towing vehicles, three independent circuits, one for 1st axle, one for 2nd and 3rd axle and another for the trailer.

Emergency brake: integrated in service brake.

Parking brake: Spring-type mechanical with pneumatic control acting on 2nd and 3rd axle wheels.

IVECO BRAKE TURBO engine brake:

Braking power 295 kW (408 cv)

On request:

Hydraulic intarder.

1st axle immobiliser system.

OFF/ROAD button for excluding ABS.



ELECTRICAL SYSTEM

Voltage: 24 V

Alternator generator 90 A - 28 V (2520 W).

Accumulators: 2 in series, 170 Ah.

Starter 24 V 5,5 kW.

Mechanically controlled electrical circuit breaker.

ABS with 4-conduits and 4-electric valves electronic system.

Phonic wheels and sensors on 1st and 3rd axle.

1 electrical joint 7-pole(ISO 7638) for trailer ABS (if applicable).

1 electrical joint 15-pole(ISO 12089-4091) for trailer lighting (if applicable).

Electrical provision for outfitters.

Provision for diagnostics.

Provision for radio/cb (without speakers).

Glow plug for cold start.

On request:

220 Ah accumulators;

170 Ah tropicalised accumulators;

Reverse alarm;

Electrically controlled main current circuit breaker.





CAB

White cab built in galvanised pressed steel with hydraulic tilting up to 60°.

Cab suspension with 4 helicoidal springs with coaxial shock absorbers and integrated dampers, anti-roll bar and end-of-stroke pads. Electric door windows.

Mechanical rear view mirrors and front view mirror. Internal panels completely washable and fireproof. Compressed air quick coupling for cab cleaning.

4-speed ventilation and heating system with air recirculation system. Air suspended 3-way adjustable driver seat with seat belt. Mechanical passenger seat with seat belts.

On request:

- Additional central seat;
- Air conditioning;
- Anti-fog lights;
- Cab rear window;
- Car radio RDS, CD;
- Car radio RDS, CD, MP3, Blue Tooth technology;
- Centralized closing of the doors with remote control;
- External sun visor.
- Heated and electric powered rear view mirrors;
- Long cab version;
- Roof hatch.



INSTRUMENTATION

Dashboard and ergonomic instrument board contain the function buttons and the identification commands.

Indicator lights: engine oil low pressure, alternator charging low, main beam lights, side lights, engine warm-up, rear fog light, hazard lights, tractor turn indicators, trailer turn indicators (if applicable), rotating lights, cab lifted, axles differential locked, differential lock, front brakes air pressure low, rear brakes air pressure low, trailer brakes air pressure low (if applicable), parking brake engaged, splitter (reduction on), slow speeds (1-4/9-12), power take-off on (if applicable) air filters clogged, power steering oil level low, rear view mirrors heated (if applicable), ABS, trailer ABS (if applicable), main steering circuit failure, steering auxiliary circuit failure.



SERVICE DATA(I)

Engine oil sump and filters	28
Gearbox oil	13
Power steering oil.....	18
Cab tipping oil	1
Transferer oil	10
Front axle with final red. oil.....	22,5
Intermediate axle with final red. oil.....	21,5
Rear axle with final red. oil	22,5
Diesel.....	300

ASTRA Veicoli Industriali

Via Caorsana, 79
 29122 Piacenza (Italy)
 Tel. ++39-523/5431
 Fax ++39-523/59.17.73
 www.astraspa.com

DEALER

Characteristics and equipment are subject to changes without prior notice.



Technical data and general specifications - validity to be checked according to each individual country